



ACS CARDAN SHAFTS
SIME™ BRAKE



ACS CARDAN SHAFTS

APPLICATIONS







- Steel cranes
- Gantry cranes
- Travelling cranes

BENEFITS

- Long service life: closed bearing yokes
- No costs of maintenance: innovative U-joint for no lubrication
- No machine down time: no lubrication requirement
- Higher torque capacity: perfected geometries
- Lower wear: optimised spline
- Maximum weld seam quality: certification DIN ISO 3834-2 and DIN EN 15085-2 CL1
- Highest possible strength and minimum deformation under load
- Excellent operational safety
- Optimally scaled product portfolio

CONFIGURATIONS

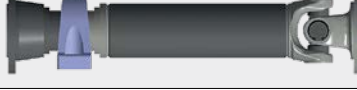
To provide the optimum cardan shaft for your application, seven different configurations are the basis for dimensioning and calculation for your cardan shaft.

	CONFIGURATIONS	DESCRIPTION
100		With length compensation
105		With length compensation in double-flange design
110		Short couple shaft
130		Tube shaft without length compensation
135		Tube shaft without length compensation in double-flange design
160		Intermediate shaft
220		Intermediate tube shaft

LENGTHS

The working length **Lw** defines:

- The distance between the drive and output units and,
- The values of length variation occurring during operation or at standstill.

Cardan shafts without length compensation have a constant length **L1** corresponding to the working length.

L1 = compressed length
L2 = maximum possible length compensation
Lw max. = maximum possible working length
 Optimal working length = **Lw opt.** = **L1 + ½ L2**

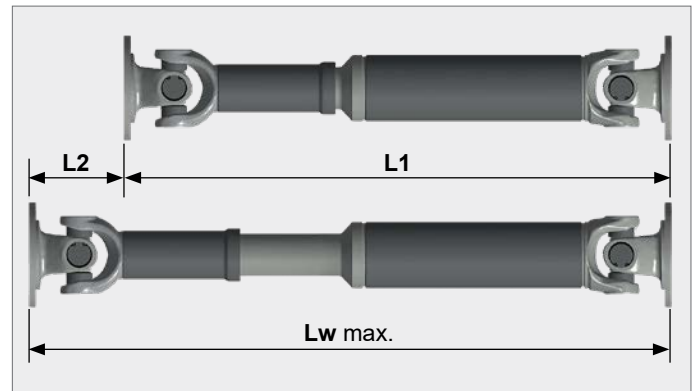

SIZES

SIZE	SWING DIAMETER mm	BEARING TORQUE Nm	FEATURE
1	up to 76	up to 600	One-piece bearing yokes - Length compensation with involute spline Flange yoke with DIN or SAE connection
2	100 - 144	1.400 - 6.000	One-piece bearing yokes - Maintenance-free - U-joints Length compensation with involute spline Flange yoke with DIN, SAE or cross-serrated connection
3	158 - 204	8.800 - 20.000	One-piece bearing yokes - Maintenance-free - U-joints Length compensation with involute spline or straight flank spline (SAE) Application-related spline coating Flange yoke with DIN, SAE or cross-serrated connection, as well as with face key
4	220 - 315	26.000 - 143.000	One-piece bearing yokes - Maintenance-free - U-joints Length compensation with involute spline or straight flank spline (SAE) Application-related spline coating Flange yoke with DIN, face key or Hirth-serration
5	350 - 620	210.000 - 1.250.000	One-piece bearing yokes - Double flange design Length compensation with involute spline or straight flank spline (SAE) Application-related spline coating Flange yoke with DIN, face key or Hirth-serration
6	à partir de 680	à partir de 1.950.000	One-piece bearing yokes - Double flange design Length compensation with straight flank spline (SAE) Application-related spline coating Flange yoke with face key or Hirth-serration







SIME™ Brakes Industrial Braking Systems

ACS Cardan Shafts

TECHNICAL DATA / DIMENSIONS

Revision number: T10155-01-D Revision date: 01.02.2023





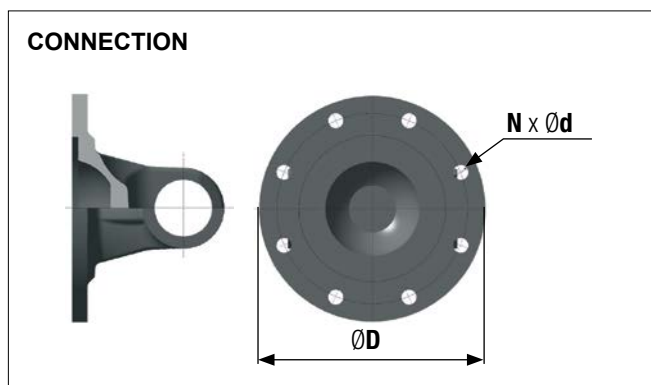

SERIES 1, 2 and 3

SERIE		1	2		3						
SIZE		07600	10000	11600	12600	15800	17200	17800	20400		
CONFIGURATION	Bearing Torque	Nm	600	1.400	3.000	5.300	8.800	12.500	17.000	20.000	
	Reversing Fatigue Torque	Nm	300	700	1.500	2.300	4.400	5.100	8.500	11.000	
	Joint Performance Factor	Nm	220	660	990	1.780	2.400	3.500	4.600	6.800	
	Swing Diameter	mm	76	100	116	126	158	172	178	204	
		L1 min		251	421	451	536	560	566	661	746
		L2 min		80	110	110	110	110	110	110	140
		tube size		50	50 / 76,2	70 / 90	90	120	120	120	140
		L1 min		225	240	290	340	400	430	450	480
		L2 min		25	15	30	40	35	40	40	40
		L1 max		245	420	450	535	559	565	660	745
		L2 max		35	110	110	110	110	110	110	140
		L1 min		148	218	278	309	355	400	353	421
		tube size		50	50 / 76,2	70 / 90	90	120	120	120	140
CONNECTION (ØD-N-Ød)	DIN 		75-6-6 90-4-8	90-4-8 100-6-8 100-8-8 120-8-8 120-8-10	100-6-8 120-8-8 120-8-10 150-8-10 150-8-12	120-8-10 150-8-12 180-8-14	150-8-12 180-8-14 180-8-16 180-10-16	180-8-14 180-8-16 180-10-16 225-8-16 250-8-18	180-8-14 180-8-16 180-10-16 225-8-16 250-8-18		
		SAE 	87-4-8	87-4-8 97-4-9,5 115-4-11,1	115-4-11,1 146-4-12,7	146-4-12,7	174,8-8-9,6 203,2-8-9,6 203,2-12-11,1	203,2-8-9,6 203,2-12-11,1	203,2-8-9,6 203,2-12-11,1 205-12-12,4	203,2-12-11,1 244,5-8-16,1 205-12-12,4	
		Cross serration 		100-4-8,5 122-4-11	122-4-11	122-4-11	150-4-13 180-4-15	150-4-13 180-4-15	150-4-13 180-4-15	180-4-15	

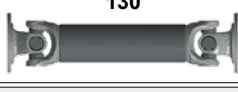

	17800	20400
DIN with face key (w x k) 	225-8-17 (32x9)	225-8-17 (32x9) 250-8-19 (40x12,5)

SERIES 4 and 5

SERIE		4					5			
SIZE		21510	22580	25080	28580	31510	35000	39000	44000	
CONFIGURATION	Bearing Torque	Nm	29.000	45.000	70.000	100.000	143.000	210.000	300.000	500.000
	Reversing Fatigue Torque	Nm	14.500	23.000	35.000	50.000	70.000	100.000	150.000	250.000
	Joint Performance Factor	Nm	8.350	12.050	19.650	26.200	35.000	40.300	56.800	81.500
	Swing Diameter	mm	220	225	250	285	315	350	390	440
		L1 min	775	900	995	1.115	1.205	1.295	1.450	1.660
		L2 min	140	140	140	140	150	150	170	190
		tube size	150	160 / 170	180	200	215	245	273	324
		L1 min	579	585	645	990	980	1.175	1.140	1.300
		L2 min	40	40	40	50	100	50	80	70
		L1 max	650	899	994	1.114	1.204	1.294	1.449	1.659
L2 max		110	140	140	140	140	150	170	190	
	L1 min	538	615	680	760	890	950	1.040	1.250	
	tube size	150	160 / 170	180	200	215	245	273	324	
CONNECTION (ØD-N-Ød)	DIN 	225-8-16	225-8-16	250-8-18	285-8-20	315-8-22	350-10-22	390-10-24	435-10-27	
		250-8-18	250-8-18	285-8-20	315-8-22	350-10-22	390-10-24	435-10-27		
		285-8-20	285-8-20	315-8-22						
	DIN with face key (w x k) 	225-8-17 (32x9)	225-8-17 (32x9) 250-8-19 (40x12,5) 285-8-21 (40x15)	250-8-19 (40x12)	285-8-21 (40x15)	315-10-23 (40x15)	350-10-23 (50x16)	390-10-25 (70x18)	435-16-28 (80x20)	
		250-8-19 (40x12,5)		285-8-21 (40x15)	315-10-23 (40x15)	350-10-23 (50x16)	390-10-25 (70x18)	435-16-28 (80x20)	480-16-31 (90x22,5)	
	Hirth serration 						350-12-18 390-12-20	390-12-20 435-16-20	435-16-20 480-16-22	

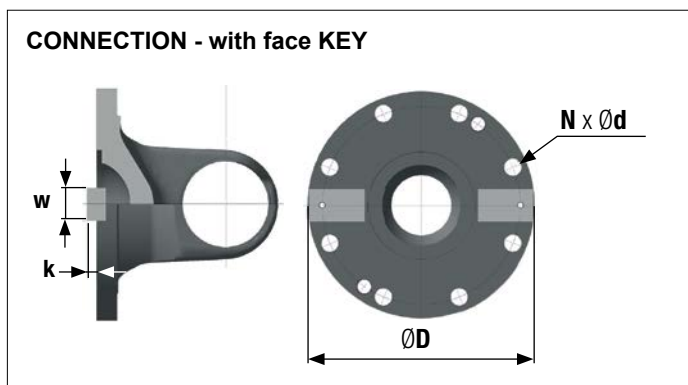







SIME™ Brakes Industrial Braking Systems

ACS Cardan Shafts

TECHNICAL DATA / DIMENSIONS

Revision number: T10155-01-D Revision date: 01.02.2023

SERIES 5 and 6

SERIE		5			6				
SIZE		49000	55000	62000	68000	75000	84000		
CONFIGURATION	Bearing Torque	Nm	700.000	1.000.000	1.250.000	1.950.000	2.650.000	3.900.000	
	Reversing Fatigue Torque	Nm	345.000	500.000	625.000	950.000	1.650.000	1.850.000	
	Joint Performance Factor	Nm	112.000	154.000	210.000	320.000	750.000	2.230.000	
	Swing Diameter	mm	490	550	620	680	750	840	
	100 	L1 min		1.810	1.965	2.240			
		L2 min		190	240	250			
		taille tube		355	406	445			
	110 	L1 min		1.300	1.770	2.050			
		L2 min		50	55	55			
		L1 max		1.809	1.964	2.239			
		L2 max		190	240	250			
	130 	L1 min		1.360	1.480	1.690			
		tube size		355	406	445			
	105 	L1 min					3.250	4.000	4.250
		L2 min					250	250	250
taille tube						559	609	660	
135 	L1 min					1.950	2.400	2.700	
	tube size					559	609	660	
CONNECTION (ØD-N-Ød)	DIN with face key (w x k) 		480-16-31 (90x22,5)	550-16-31 (100x22,5)	620-16-38 (100x25)				
			550-16-31 (100x22,5)	620-16-38 (100x25)					
CONNECTION (ØD-N-Ød)	Hirth serration 		480-16-22	550-16-24	620-24-26	680-24-33	750-24-33	840-24-38	
			550-16-24	620-24-26	680-24-33				



Regal Rexnord™

[regalrexnord.com](https://www.regalrexnord.com) [stromag.com](https://www.stromag.com)

Customer Service: +33 (0)1 49 90 32 20

Technical Service: +33 (0)6 07 23 14 80

sales.LaGuerche@regalrexnord.com

The proper selection and application of products and components, including assuring that the product is safe for its intended use, are the responsibility of the customer. To view our Application Considerations, please visit <https://www.regalrexnord.com/Application-Considerations>.

To view our Standard Terms and Conditions of Sale, please visit <https://www.regalrexnord.com/Terms-and-Conditions-of-Sale>.

"Regal Rexnord" is not indicative of legal entity. Refer to product purchase documentation for the applicable legal entity. Regal Rexnord and Stromag are trademarks of Regal Rexnord Corporation or one of its affiliated companies.

© 2019, 2024 Regal Rexnord Corporation, All Rights Reserved. MCC-P-8820-SG-EN-A4 09/24

RegalRexnord™