

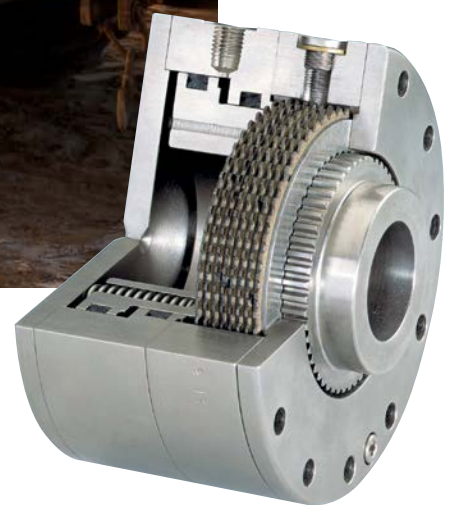

**Hydraulically  
and  
Pneumatically  
Operated  
Clutches and  
Brakes**



**YOUR DRIVES ARE SAFE WITH US**



Stromag has for decades been a highly regarded partner in the area of mechanical drive engineering. Attractive, tailor-made and cost-effective solutions combined with products of a high standard of quality guarantee optimum customer benefits.

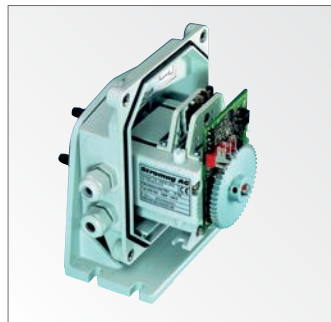

We specialise in wet and dry running clutches/brakes solutions for torsional vibrations in the drive train and a service conception tailored to suit the individual requirements of our customers.

Stromag is the leader in the area of industrial disc brakes, in particular for the wind turbine market. Stromag clutches and flexible couplings, spring-applied brakes, discs and limit switches have a leading position in the world market.



Clear strategic focus on core technologies in production and core applications enable short construction and delivery times. Exceptional engineering know-how is a further outstanding strength as a basis for solid customer partnerships.

Stromag products are innovatively tailored to meet specific market requirements and features in virtually all mechanical drives. Drive solutions specially tailored to our customers' needs optimise processes and minimise operating costs.

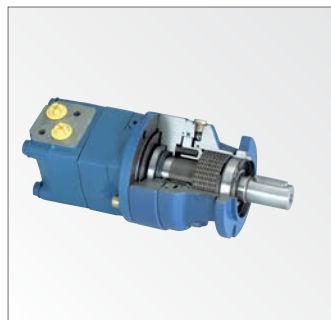

## SOLUTIONS FOR YOUR APPLICATION

Hydraulically or pneumatically operated clutches and brakes are highly advanced and reliable components for modern energy-efficient drives. These units control individual drive trains on modern agricultural machines such as combine harvesters and forage harvesters, as well as the power flow in various hybrid drives.

In conjunction with flexible Stromag couplings, drives subject to impact or shock loads such as road millers or stone crushers are comfortably controlled.

Hydraulically or pneumatically operated brakes in drives ensure stability of construction machinery and keep rotary drives in the required position. Winches on cranes or ships are also braked and held under difficult conditions.

High torques and small dimensions are two significant characteristics of hydraulically operated clutches and brakes. By selecting suitable friction linings and influencing pressure build-up, the operating characteristics can be adapted to meet specific requirements.

This brochure contains several clutch and brake series on the basis of which we can develop solutions tailored to your particular application.



## STROMAG KMK

- Universal, hydraulically operated multi-disc clutch. Suitable for wet or dry operation.
- Various friction linings with different properties are available.
- Transmittable torques from 200 Nm to 140,000 Nm.
- Other sizes and customer-specific adaptations available on request.  
Pneumatic option also available.

### INSTALLATION IN GEARBOX (WET OPERATION)

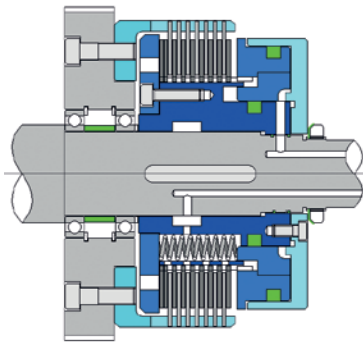

**Stromag KMK** for use in gearboxes (wet operation) with optional disc oil flushing. Hydraulic and cooling oil supplied via the transmission shaft.

### MOUNTING ON GEARBOX (DRY OPERATION)

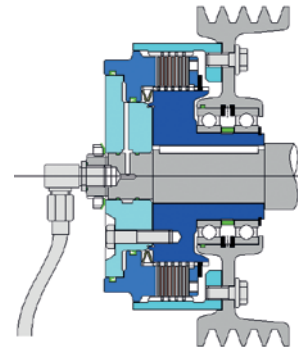

**Stromag KMK** as a shaft-pulley connection for use outside gearboxes (dry operation). Hydraulic oil can be supplied axially through the shaft. Available as a completely assembled and bearing supported unit.

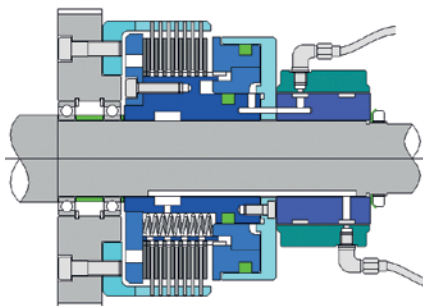

**Stromag KMK** for use in gearboxes (wet operation) with optional disc oil flushing. Hydraulic and cooling oil supplied via integrated radial oil supply (KRE).  
No bores in the transmission shaft.

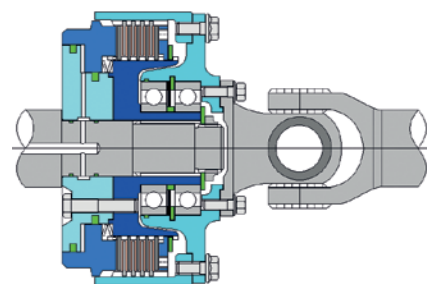

**Stromag KMK** as a shaft-cardan shaft connection for use outside gearboxes (dry operation). Hydraulic oil supplied axially through the shaft. Available as a completely assembled and bearing supported unit.

## STROMAG KUK

- Hydraulic multi-disc clutch with hammer head discs.
- Designed specially for dry operation on drives subject to torsional vibrations.
- Transmittable torques from 1,600 Nm to 6,000 Nm.
- Other sizes and customer specific adaptations available on request.
- Pneumatic option also available.

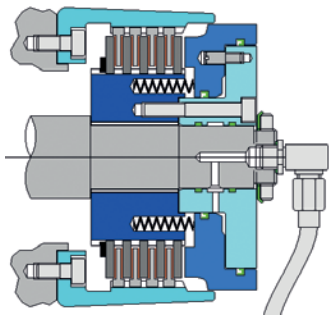

**Stromag KUK** as a basic type. For use outside gearboxes (dry operation). Hydraulic oil supplied axially through the shaft. Customer-specific adaptations of shaft and external body connections possible.

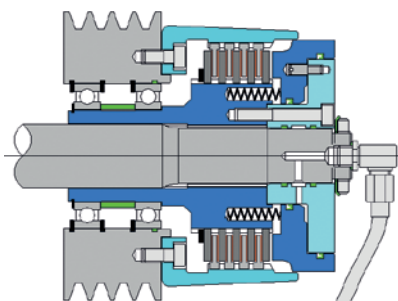

**Stromag KUK** as a shaft-pulley connection for use outside gearboxes (dry operation). Hydraulic oil supplied axially through the shaft. Available as a completely assembled and bearing supported unit.

## STROMAG KHM

- Hydraulic clutches with low or backlash-free torque
- Transmission via diaphragms. Minimal residual torque when open. Suitable for direct use on internal combustion engines.
- Transmittable torques from 600 Nm to 5,000 Nm.
- Other sizes and customer-specific adaptations available on request.
- Pneumatic option also available.

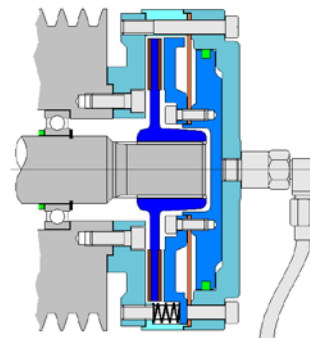

**Stromag KHM** as a shaft-pulley connection. Backlash-free power transmission on pulley side through external body and piston with diaphragm guidance. Friction lining carrier on shaft side with low wearing, wide sliding gear.

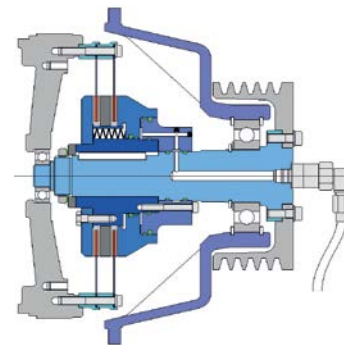

**Stromag KHM** for engine mounting. Backlash-free power transmission via diaphragm guided pistons and friction linings. Drag torque free when open. Connection for SAE flywheels. Housings for SAE sizes 1 to 4 possible.

## STROMAG KHA

- Dry, hydraulically operated multi-disc clutches in housings with SAE connection sizes for mounting on diesel engines
- Reinforced inner discs and outer discs with hammer head for low gear wear.
- Transmittable torques from 500 Nm to 5,000 Nm.
- Other sizes and customer-specific adaptations available on request.
- Pneumatic option also available.

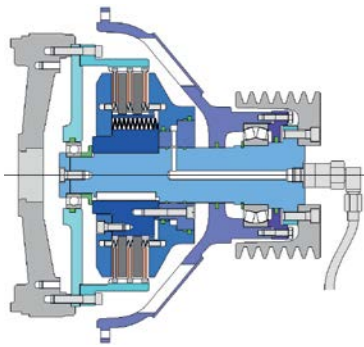

**Stromag KHA** with additional carrier for heavy-duty pilot bearing and bracing springs for reducing drag torque. Connection for standard flywheels. Housings for SAE sizes 1 to 4 possible.

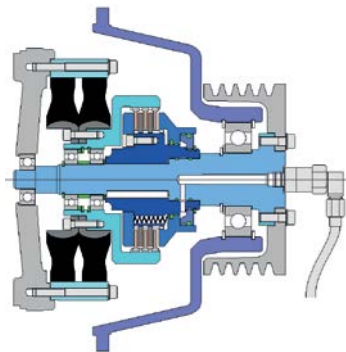

**Stromag KHA** with flexible Periflex® VN couplings for drives particularly subject to torsional vibrations. Connection for SAE flywheels. Housings for SAE sizes 1 to 4 possible.

## STROMAG KHR

- Hydraulically operated multi-disc clutches with rotating piston. For use mainly outside gearboxes (dry operation) when no axial oil supply is possible
- Transmittable torques from 200 to 12,000 Nm
- Other sizes and customer-specific adaptations available on request.
- Pneumatic option also available

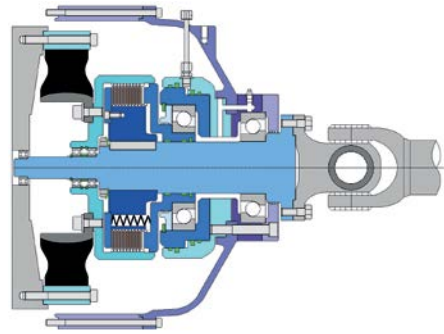

**Stromag KHR** as a "Two in One" combination in SAE housing on diesel engine with direct flange-mounted cardan shaft.

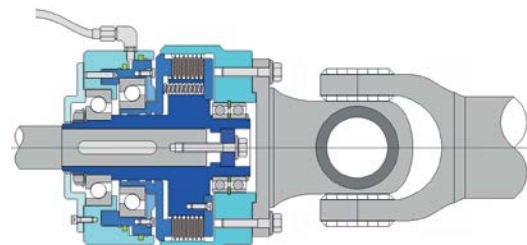

**Stromag KHR** as a complete unit for preassembly with supported external body as a shaft-shaft connection.

## STROMAG KMB

- Universal hydraulically released, spring-applied multi-disc brake. For use in or outside gearboxes (wet or dry operation) as well as a holding brake with emergency stop function.
- Various friction linings with different properties are available
- Transmittable torques from 100 Nm to 130,000 Nm
- Other sizes and customer specific adaptations available on request
- Pneumatic option also available

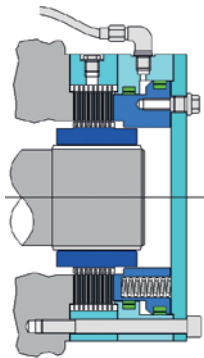

**Stromag KMB** standard type for direct mounting on shaft end on gearbox or motor. Alternatively with or without sealed shaft bushing.

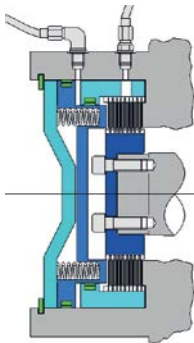

**Stromag KMB** adapted customer-specific requirements. Integrated in a gearbox.

## STROMAG KMB.ZM

- Hydraulically released, spring-applied multi-disc brake in own housing with standard flange connections for mounting between gearbox and hydraulic motors
- Flange types and shaft connections according to customer requirements
- Transmittable torques from 270 to 2,000 Nm
- Other sizes and customer specific adaptations available on request
- Pneumatic option also available.

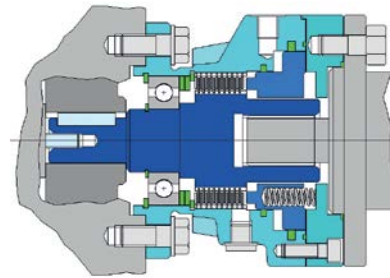

**Stromag KMB.ZM** mounted between gearbox and hydraulic motor.

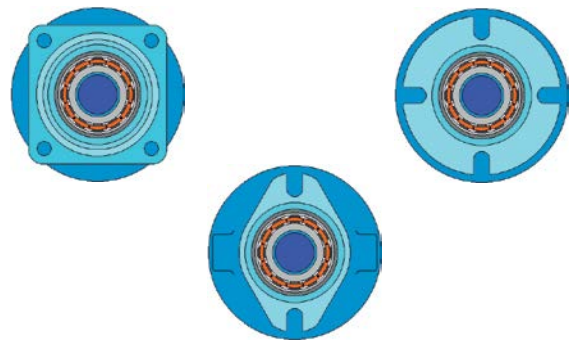

Connection flanges according to SAE standard or customer specifications.

## Stromag Facilities

### Europe

#### Germany

Hansastraße 120  
59425 Unna - Germany  
+49 (0) 23 03 102 0

*Clutches & Brakes, Couplings,  
Geared Cam Limit Switches, Discs,  
Wind Brakes*

Dessauer Str. 10  
06844 Dessau-Roßlau - Germany  
+49 (0) 340 2190 0

*Electromagnetic Clutches & Brakes*

#### France

Avenue de l'Europe  
18150 La Guerche sur L'Aubois - France  
+33 (0)2 48 80 72 72

*Industrial Caliper & Drum Brakes*

#### Great Britain

11 Fleming Close  
Park Farm Industrial Estate  
Wellingborough NN8 6UF  
+44 (0)1933 675494

*Electromagnetic Clutches & Brakes,  
Industrial Caliper Brakes*

### North America

#### USA

31 Industrial Park Road  
New Hartford, CT 06057 - USA  
860-238-4783

*Electromagnetic Clutches & Brakes*

300 Indiana Highway 212  
Michigan City, IN 46360 - USA  
219-874-5248

*Couplings*

2800 Fisher Rd.  
Wichita Falls, TX  
940-723-3400

*Geared Cam Limit Switches,  
Industrial Caliper & Drum Brakes*

### Asia Pacific

#### China

T40B -5, No. 1765 Chuan Qiao Road  
Pudong 201206, Shanghai - China  
Tel +86 21-60580600

*Clutches & Brakes, Electromagnetic  
Clutches & Brakes, Couplings, Industrial  
Caliper & Drum Brakes, Discs, Geared  
Cam Limit Switches, Wind Brakes*

#### India

Gat No.: 448/14, Shinde Vasti, Nighoje  
Tal Khed, Pune- 410 501  
+91 2135 622100

*Clutches & Brakes, Electromagnetic  
Clutches & Brakes, Couplings, Industrial  
Caliper & Drum Brakes, Discs, Geared  
Cam Limit Switches, Wind Brakes*

## The Brands of Altra Industrial Motion

### Couplings

**Ameridrives**  
[www.ameridrives.com](http://www.ameridrives.com)

**Bibby Turboflex**  
[www.bibbyturboflex.com](http://www.bibbyturboflex.com)

**Guardian Couplings**  
[www.guardiancouplings.com](http://www.guardiancouplings.com)

**Huco**  
[www.huco.com](http://www.huco.com)

**Lamiflex Couplings**  
[www.lamiflexcouplings.com](http://www.lamiflexcouplings.com)

**Stromag**  
[www.stromag.com](http://www.stromag.com)

**TB Wood's**  
[www.tbwoods.com](http://www.tbwoods.com)

### Geared Cam Limit Switches

**Stromag**  
[www.stromag.com](http://www.stromag.com)

### Electric Clutches & Brakes

**Inertia Dynamics**  
[www.idicb.com](http://www.idicb.com)

**Matrix**  
[www.matrix-international.com](http://www.matrix-international.com)

**Stromag**  
[www.stromag.com](http://www.stromag.com)

**Warner Electric**  
[www.warnerelectric.com](http://www.warnerelectric.com)

### Linear Products

**Warner Linear**  
[www.warnerlinear.com](http://www.warnerlinear.com)

### Engineered Bearing Assemblies

**Kilian**  
[www.kilianbearings.com](http://www.kilianbearings.com)

### Heavy Duty Clutches & Brakes

**Industrial Clutch**  
[www.indclutch.com](http://www.indclutch.com)

**Twiflex**  
[www.twiflex.com](http://www.twiflex.com)

**Stromag**  
[www.stromag.com](http://www.stromag.com)

**Svendborg Brakes**  
[www.svendborg-brakes.com](http://www.svendborg-brakes.com)

**Wichita Clutch**  
[www.wichitaclutch.com](http://www.wichitaclutch.com)

### Belted Drives

**TB Wood's**  
[www.tbwoods.com](http://www.tbwoods.com)

### Gearing

**Bauer Gear Motor**  
[www.bauergears.com](http://www.bauergears.com)

**Boston Gear**  
[www.bostongear.com](http://www.bostongear.com)

**Delroyd Worm Gear**  
[www.delroyd.com](http://www.delroyd.com)

**Nuttall Gear**  
[www.nuttallgear.com](http://www.nuttallgear.com)

### Overrunning Clutches

**Formsprag Clutch**  
[www.formsprag.com](http://www.formsprag.com)

**Marland Clutch**  
[www.marland.com](http://www.marland.com)

**Stieber Clutch**  
[www.stieberclutch.com](http://www.stieberclutch.com)



[www.stromag.com](http://www.stromag.com)

Hansastraße 120  
59425 Unna - Germany  
+49 2303 102-0